

Digital Temperature Controller

RB SERIES



Reinforced Insulation
RoHS compliant



Panel space saving : 60mm depth

The RB Series has very short depth.
The series was designed with a mounting bracket that allows close horizontal mounting of as many as six units.

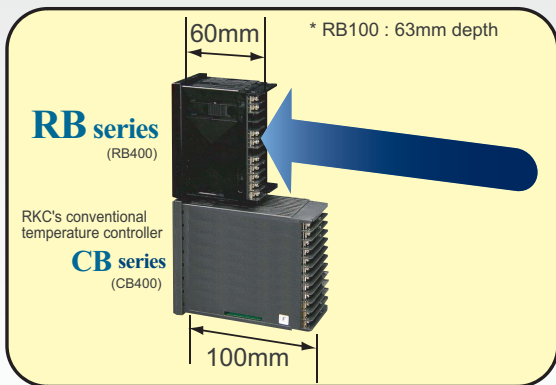

Easy-to-read with large 11-segment LCD display

So bright and so large it is easy to read from a greater distance.

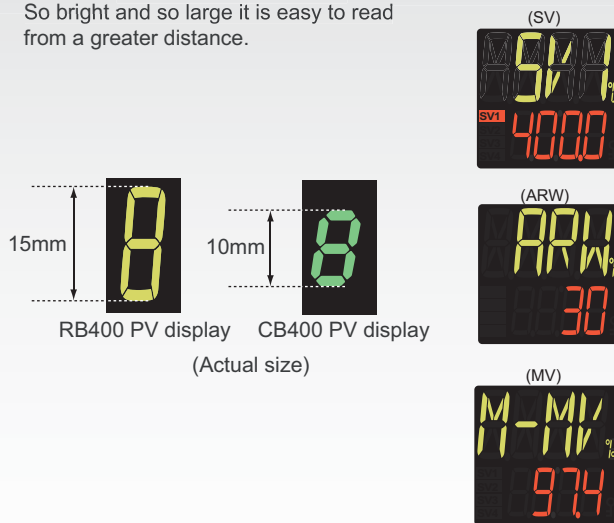

Four set values can be stored

In the factory default state, only one set value, SV1, can be stored. (It is possible to change to a 4-SV specification.)

Up to four set values (SV) can be stored. Set value changeover is also possible by digital input.

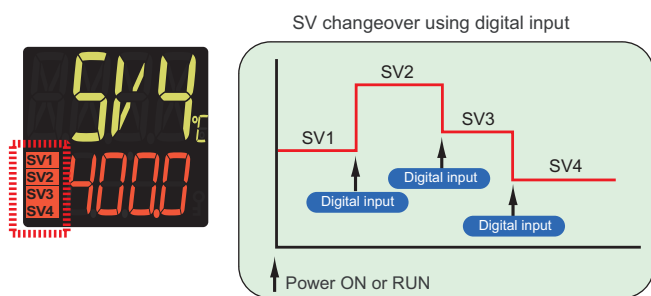

Simple program control using a timer function / setting change proportion limiter

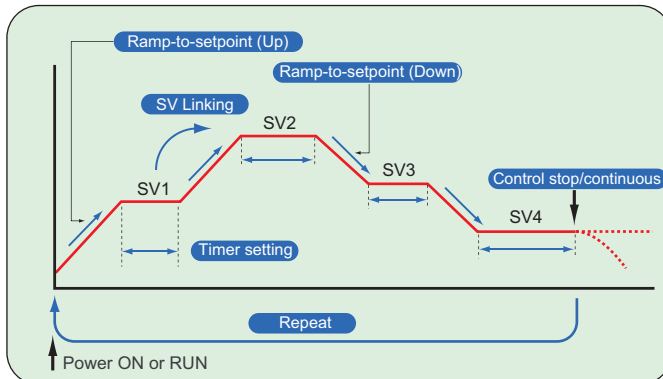

Numerous inputs and outputs

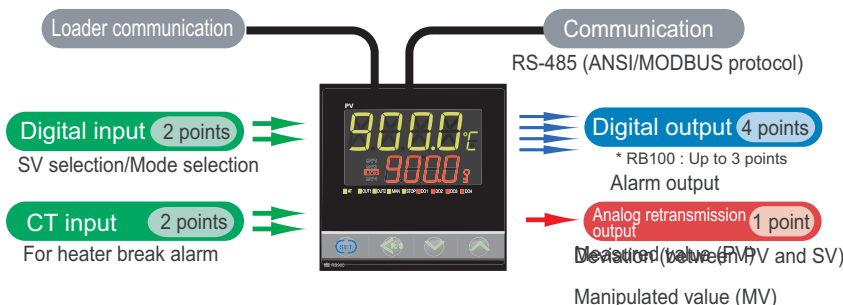

- The number of digital outputs is limited depending on the model and specifications.
- An analog output cannot be added to some control types and models.
- On the RB100, communication or digital input can be selected.

Reinforced Insulation

Reinforced insulation retains its insulating ability even when basic insulation breaks down. This eliminates the need for safety measures to prevent break-down shock. The power circuits in our devices are designed with reinforced insulation. Reinforced insulation also eliminates the need to add basic insulation on the device side, reducing device cost.

<Requirements for electrical equipment according to safety standards>
The safety standards on electrical equipment (JISC 1010-1 and IEC 61010-1) request that the secondary side of the equipment which may be touched by the operator should be double insulated or reinforcement insulated* from high voltage causing electric shock.
* Insulation safeguarding personnel from electric shock which is equal to double insulation or higher is called "reinforced insulation".

High Performance Budget Friendly Temperature Controller

Save space and save money with a new series that gives outstanding control capability and comprehensive functions incorporated into a slim body case.

Calculates optimum PID values to stabilize control faster than ever

The improved autotuning algorithm calculates optimum PID values that shortens the time to reach stable control at the set value as well as eliminating overshoot/undershoot. The new PID algorithm also suppress overshoot/undershoot against external disturbance.

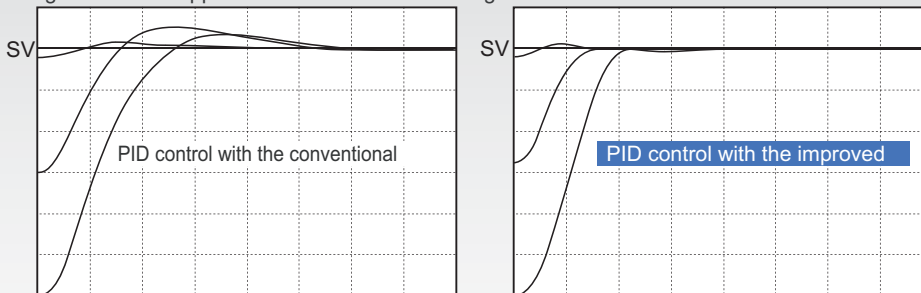

Sampling 0.25sec

The RB high performance controller provides precise control by sampling every 0.25 seconds.

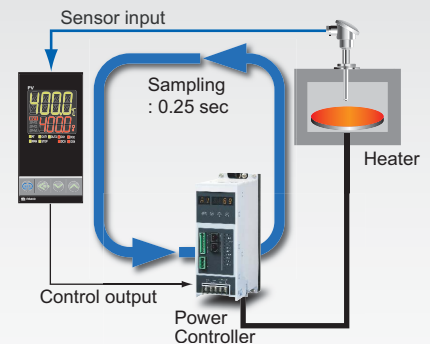

Easy Fine tuning with 6-level of control response adjustment

After the PID values have been autotuned, the Fine tuning (FT) function allows the operator to adjust the control response speed with a 6-level adjustment parameter (-3 to +3) without changing PID value.

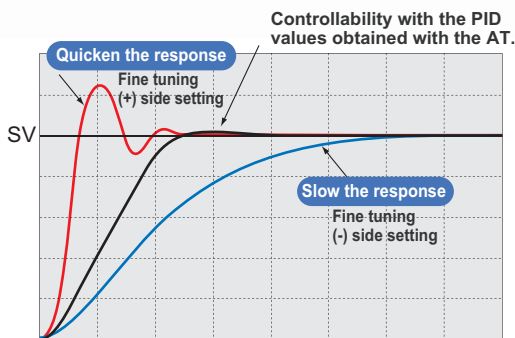

6-stage Fine tuning (-3 to +3) to adapt to the control object
 -3 to -1: Faster response
 1 to 3: Slower response
 0: Function OFF

Startup tuning

Startup tuning eliminates time required for conventional autotuning as it calculates optimum PID values by temperature characteristics at start up. It is useful in applications which require a long time for conventional autotuning. The timing of activation of start-up tuning can be selected from at power-up, at setpoint change, and at power-up/setpoint change. It is also settable to Only-once or always-ON.

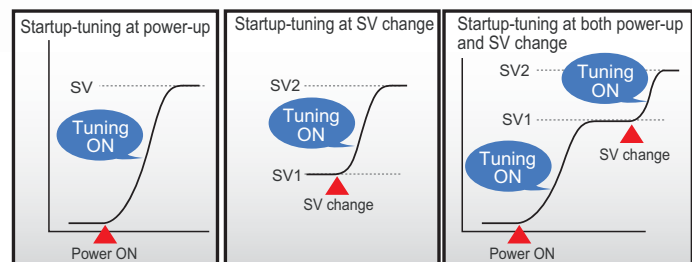

- Startup tuning function can be set ON/OFF
- Heater power needs to be turned on simultaneously with or before turning on power to the temperature controller.
- If startup tuning does not calculate suitable PID values due to characteristics of application, use Autotuning function.

Easy parameter setup via USB loader port (Loader communication)

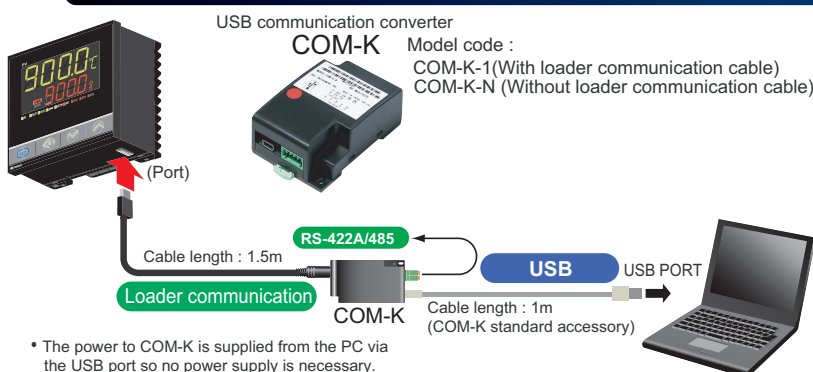

* The power to COM-K is supplied from the PC via the USB port so no power supply is necessary.

The RB series has a standard loader port to connect to a PC USB port via COM-K (USB communication converter). Using Win-UCI software on the PC, parameter settings can be easily saved on the PC in CSV format and the same parameter setting are easily copied to other controllers.

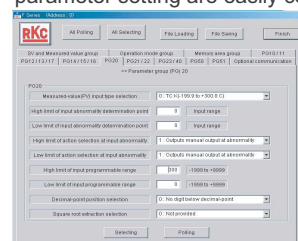

Specifications

Input

Input	<p>a) Temperature input group Thermocouple : K, J, E, T, R, S, B, N (JIS/IEC) PLII (NBS), W5Re/W26Re (ASTM) RTD : Pt100 (JIS/IEC), JPt100 (JIS) • 3-wire system</p> <p>b) Voltage/Current input group Voltage input (Input impedance : Approx.1MΩ) 0 to 1V DC, 0 to 5V DC, 1 to 5V DC, 0 to 10V DC Current input (Input impedance : 250Ω) 4 to 20mA, 0 to 20mA</p> <p>• For current input, connect is a 250Ω shunt resistor to the input terminals. Model code : KD100-55 • Inputs is selectable within each group.</p>
Input break action	Thermocouple input : Up-scale/Down-scale (Selectable) RTD input : Up-scale Voltage input : Value around 0V Current input : Value around 0mA
Input short action	Down-scale (RTD input)
Sampling time	0.25sec
Influence of external resistance	0.25 μ V/ Ω (Thermocouple input)
Influence of lead resistance	0.02% of reading/ Ω (RTD input) • Maximum 10 Ω per wire
PV bias	Temperature input : -1999(-199.9) to +9999(999.9) $^{\circ}$ C Voltage/Current input : -span to +span
Input digital filter	0.1 to 100.0 sec. (OFF when 0 is set.)

Display

Display method	PV : 11 segment (4 digits), SV : 7 segments (4 digits) LCD display
----------------	---

Performance

Measuring accuracy	See measuring accuracy code table
Influence of ambient temperature	Temperature input : $\pm 0.06^{\circ}$ C/ $^{\circ}$ C [at 5 to 40 $^{\circ}$ C] Voltage/Current input group : $\pm 0.06\%$ of span/ $^{\circ}$ C [at 5 to 40 $^{\circ}$ C]
Close horizontal mounting error	$\pm 2^{\circ}$ C (3.6 $^{\circ}$ F) [Less than -100 $^{\circ}$ C (-146 $^{\circ}$ F) input : $\pm 3.5^{\circ}$ C (6.3 $^{\circ}$ F)]
Insulation resistance	More than 20M Ω (500V DC) between measured terminals and ground More than 20M Ω (500V DC) between power terminals and ground
Dielectric voltage	1000V AC for 1 minute between measured terminals and ground 1500V AC for 1 minute between power terminals and ground

Setting

SV limiter	Scaling low to scaling high (High/Low individual setting)
Ramp-to-setpoint	1(0.1) to span per Time (Time : 1 minute/1 hour (Selectable) Up/Down individual setting)
SV step function	Number of SV : 4 points (Default : 1 point) SV selecting method : Front key, Communication, Digital input (External contact input)
Timer function	Timer setting : 0 min 01 sec to 99 min 59 sec or 0 hr 01 min to 99 hr 59 min (selectable) Function 1: Control starts after the timer time elapses. 2: Control is performed during the timer time and stops after the timer time elapses. 3:Link function from SV1 to SV4 (After the timer time elapses, control is continued using SV4.) 4:Link function from SV1 to SV4 (After the timer time elapses, control is stopped.) Repeat : 0 to 9999 (Continuous when when 9999 is set.)
Setting data lock	Lock level : 1 to 10 level (0 : No lock)

Loader communication

Protocol	ANSI X3.28 sub-category 2.5A4 (RKC standard)
Communication speed	9600bps
Maximum connection	1 unit

● Measuring accuracy table

Input Type	Range	Accuracy
K, J, T, E ^{*1}	Lower than -100 $^{\circ}$ C (-148 $^{\circ}$ F)	$\pm (2.0^{\circ}$ C [3.6 $^{\circ}$ F] + 1 digit)
	-100 to 500 $^{\circ}$ C (-148 to 932 $^{\circ}$ F)	$\pm (1.0^{\circ}$ C [1.8 $^{\circ}$ F] + 1 digit)
	500 $^{\circ}$ C (932 $^{\circ}$ F) or higher	$\pm (0.2\%$ of Reading + 1 digit)
N, R, S, PLII ^{*2} W5Re/W26Re	Lower than 0 $^{\circ}$ C (32 $^{\circ}$ F)	$\pm (4.0^{\circ}$ C [7.2 $^{\circ}$ F] + 1 digit)
	0 to 1000 $^{\circ}$ C (32 to 1832 $^{\circ}$ F)	$\pm (2.0^{\circ}$ C [3.6 $^{\circ}$ F] + 1 digit)
	1000 $^{\circ}$ C (1832 $^{\circ}$ F) or higher	$\pm (0.2\%$ of Reading + 1 digit)
B	Lower than 400 $^{\circ}$ C (752 $^{\circ}$ F)	$\pm (70^{\circ}$ C [126 $^{\circ}$ F] + 1 digit)
	400 to 1000 $^{\circ}$ C (752 to 1832 $^{\circ}$ F)	$\pm (2^{\circ}$ C [3.6 $^{\circ}$ F] + 1 digit)
	1000 $^{\circ}$ C (1832 $^{\circ}$ F) or higher	$\pm (0.2\%$ of Reading + 1 digit)
Pt100, JPt100	Lower than 200 $^{\circ}$ C (392 $^{\circ}$ F)	$\pm (0.4^{\circ}$ C [0.7 $^{\circ}$ F] + 1 digit)
	200 $^{\circ}$ C (392 $^{\circ}$ F) or higher	$\pm (0.2\%$ of Reading + 1 digit)
Voltage/Current	-span to +span	$\pm (0.2\%$ of span + 1 digit)

*1 : Accuracy is not guaranteed for less than -100 $^{\circ}$ C.

*2 : Accuracy is not guaranteed for less than 400 $^{\circ}$ C (752 $^{\circ}$ F) for Input Type R, S, B, and W5Re/W26Re.

Control

Control method	PID control (With autotuning) • P, PI, PD, ON/OFF control selectable • Direct action/Reverse action is selectable Heat/Cool type PID control (With autotuning)
Startup tuning	The condition to activate Startup Tuning is selectable among a) to g) a) At power-on and stop-to-run, one-time tuning b) At SV change, one-time tuning c) At power-on, stop-to-run and SV change, one-time tuning d) At every power-on and stop-to-run e) At every SV change f) At every power-on, stop-to-run and SV change g) Function off
Fine tuning	Setting range : -3 to +3 (6 levels, OFF when set to 0.) -3 to -1 : Faster response 1 to 3 : Slower response OFF : Function OFF
Setting range	a) Proportional band : Temperature input : 1(0.1) to span ($^{\circ}$ C, $^{\circ}$ F) • When 0.1 $^{\circ}$ C ($^{\circ}$ F) resolution, within 999.9 $^{\circ}$ C ($^{\circ}$ F) Voltage/Current input : 0.1 to 100.0% of span (ON/OFF control when P = 0) • Differential gap at ON/OFF control (High/Low individual setting) : Temperature input : 0(0.0) to 100 (100.0) ($^{\circ}$ C, $^{\circ}$ F) Voltage/Current input : 0.0 to 100.0% of span b) Integral time : 1 to 3600 sec (PD control when I = 0) c) Derivative time : 1 to 3600 sec (PI control when D = 0) d) Cool side proportional band : 1 to 1000% of heat side proportional band * Invalidity when P=0. * Only cooling side ON/OFF control is not available. e) Anti-Reset Windup (ARW) : 1 to 100% of heat side proportional band (Integral action is OFF when ARW = 0) f) Deadband/Overlap Temperature input : -10 (-10.0) to 10 (10.0) $^{\circ}$ C ($^{\circ}$ F) Voltage/Current input : -10.0 to +10.0% of span • Minus setting : Overlap g) Derivative time action select 0 : PV derivative, 1 : Deviation derivative h) Output limiter PID control : -5.0 to +105.0% (High/Low individual setting) Heat/Cool type PID control : 0.0 to 105.0% (Only limiter high) (Heat side/Cool side individual setting) i) Proportional cycle time : 0.1sec, 0.25sec, 0.5sec, 1 to 100 sec j) Heat/Cool PID control selection : Air cooling, Water cooling, Linear
Manual output	a) Output range PID control : Output limiter low to Output limiter high Heat/Cool type PID control : -(Cool side output limiter high) to (Heat side output limiter high) b) Auto/Manual transfer action selection With bumpless/Without bumpless (Selectable)
Control output	a) Relay contact output, Form a contact, 250V AC 3A (Resistive load) • Electric life : 1,000,000 cycles or more b) Voltage pulse output, 0/12V DC (Load resistance : more than 600 Ω <less than 20mA>) • When out2 is no use, load resistance is more than 300 Ω <less than 10mA>. See page 7 "Maximum number of digital outputs (DO) by combinations of output (OUT1 and OUT2) c) Current output, 4 to 20mA DC, 0 to 20mA DC (Load resistance : less than 500 Ω) d) SSR (Triac) output Rated current : 0.5A (Ambient temperature : Less than 40 $^{\circ}$ C) e) Voltage output, 0 to 5V DC, 1 to 5V DC, 0 to 10V DC (Load resistance : More than 1k Ω) (Output impedance : Less than 0.1 Ω) f) Open collector output (Sink type) Load current : Less than 100mA Load voltage : Less than 30V DC Minimum load current : 0.5mA ON voltage : Less than 2V (at maximum load current) Power OFF leakage current : Less than 0.1mA

Analog Retransmission Output (AO) (Optional)

Number of outputs	1 point
Output type	Measured value (PV), Set value (SV) Manipulated value (MV) • Selectable
Output signal	4 to 20mA DC, 0 to 20mA DC (Load resistance : Less than 600 Ω) 0 to 1V DC, 0 to 5V DC, 1 to 5V DC, 0 to 10V DC (Load resistance : More than 1k Ω)
Output resolution	Approx. more than 1/2000

Digital Input (DI) (Optional)

Number of inputs	2 points (DI1, DI2)
Input method	Non-voltage contact input
Function	SV selection, STOP/RUN, Auto/Manual, Alarm interlock reset, • Selectable

Specifications

Event (Alarm) (Optional)

Number of events	Up to 4 points (RB100 : Up to 3 points, Heat/Cool type : Up to 2 points) See page 7 "Maximum number of digital outputs (DO) by combinations of output (OUT1 and OUT2)"
Event type	Process high, Process low, Deviation high, Deviation low, Deviation high/low ^{*1} , Band, Set value high, Set value low, LBA (Control loop break alarm), Heater break alarm (HBA), Output of the communication monitoring result, RUN status monitor ^{*1} : Two types of alarm settings are field-selectable. 1. Independent high and low settings. 2. Common high/low setting (Factory setting, unless specified in alarm code when ordering)
Other functions	a) Hold/Re-hold action • Hold action is activated at power-on and stop-to-run. Re-hold action is activated at power-on, stop-to-run, and the control set value change. b) Alarm output ON/OFF at stop mode is selectable. c) Energized/de-energized action is configurable. d) Differential gap : 0 (0.0) to span e) Delay timer : 0 to 600 sec f) Interlock (latch) function is configurable.
Loop break alarm (LBA)	LBA time : 0 to 7200 sec LBA deadband : 0 to input span • Loop break alarm is not available with heat/Cool PID control type.
Heater break alarm (HBA)	Number of alarms 2 points (1 point per CT input) CT Type and input range CTL-6-P-N : 0 to 30A CTL-12-S56-10L-N : 0 to 100A Display range 0.0 to 100.0A Display accuracy ±(5% of input value + 1 digit) or 2A (whichever is larger) Delay times 0 to 255 times • Heater break alarm is available for time proportioning output only.
Output	Relay contact output, Form a contact, 250V AC 1A, 30V DC 0.5A (Resistive load)

Communications (Optional)

Communication method	RS-485
Communication speed	2400bps, 4800bps, 9600bps, 19200bps
Protocol	a) ANSI X3.28 sub-category 2.5A4 (RKC standard) b) MODBUS-RTU
Bit format	a) RKC standard protocol Start bit : 1 Data bit : 7 or 8 Parity bit : 1 (odd or even) or none Stop bit : 1 or 2 b) MODBUS protocol Start bit : 1 Data bit : 8 Parity bit : 1 (odd or even) or none Stop bit : 1 or 2
Maximum connection	31 units
Terminating resistor	External installation is necessary (120Ω 1/2W)
Buffer mode	Correspond (Mode in which writing to EEPROM is not performed for setting changes)

Waterproof/Dustproof (Optional)

NEMA4X, IP66
• Waterproof/Dustproof protection only effective from the front in panel mounted installation.

General Specifications

Supply voltage	a) 90 to 264V AC (50/60Hz, Selectable) Rating : 100 to 240V AC b) 24V AC ±10% (50/60Hz, Selectable) Rating : 24V AC c) 24V DC ±10% Rating : 24V DC
Power consumption	a) 100 to 240V AC type RB900 : 9.0VA (240V), RB700 : 8.7VA (240V) RB500 : 8.7VA (240V), RB400 : 8.7VA (240V) RB100 : 8.5VA (240V) b) 24V AC type RB900 : 6.0VA, RB700 : 5.8VA RB500 : 5.8VA, RB400 : 5.8VA RB100 : 4.7VA c) 24V DC type RB900 : 147mA, RB700 : 141mA RB500 : 141mA, RB400 : 141mA RB100 : 108mA
Rush current	a) 100 to 240V AC type Less than 13.3A (240V), Less than 5.6A (100V) b) 24V AC type Less than 16.3A c) 24V DC type Less than 11.5A
Power failure	A power failure of 20msec or less will not affect the control action. • RB100, 24V AC/DC type : 10msec or less
Memory backup	Backed up by Nonvolatile memory • Data retaining period : Approx. 10 years • Number of writing : Approx. 1,000,000 times. (Depending on storage and operating conditions.)
Ambient temperature	0 to 50°C (32 to 122°F)
Ambient humidity	10 to 90%RH (Non condensing) • Absolute humidity : MAX.W.C29.3g/m3 dry air at 101.3kPa
External dimensions (W x H x D)	RB900: 96 x 96 x 60mm RB700: 72 x 72 x 60mm RB500: 96 x 48 x 60mm RB400: 48 x 96 x 60mm RB100: 48 x 48 x 63mm
Weight	RB900: Approx. 250g, RB700: Approx. 200g RB500: Approx. 190g, RB400: Approx. 185g, RB100: Approx. 120g
Compliance with standards	UL,cUL,CE,C-Tick

External Dimensions

The mounting brackets can be attached on the sides of the controller. However, to make the controller waterproof and dustproof, attach the mounting brackets to the top and bottom. (4 places).

RB900

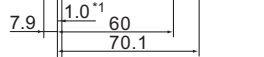
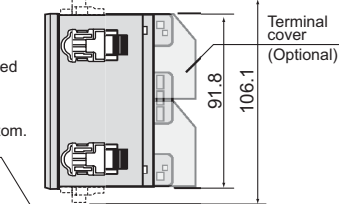

• If you specified the waterproof and dustproof structure, four mounting brackets are included with the RB900 as accessories.

^{*1} : Case rubber packing (optional) [Waterproof/dustproof]

The mounting brackets can be fixed on both sides (RB400), top and bottom (RB500), but to obtain water- and dust-proof protection, install brackets (two each) only on top and bottom (RB400) and on both sides (RB500).

RB500



RB400

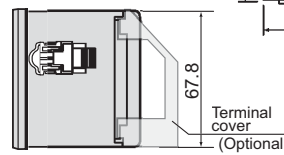
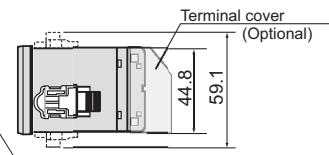
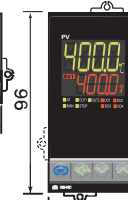

RB700

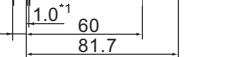
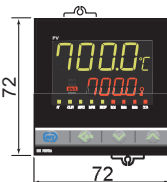

RB100

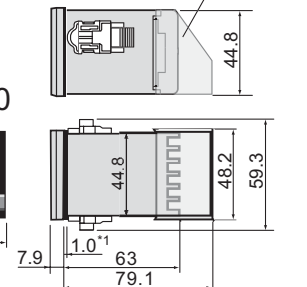

Model and Suffix Codes

Specifications		48 x 48mm (1/16 DIN size) 48 x 96mm (1/8 DIN Vertical size) 96 x 48mm (1/8 DIN Horizontal size) 72 x 72mm (3/16 DIN size) 96 x 96mm (1/4 DIN size)	RB100 RB400 RB500 RB700 RB900	① ② ③ ④ ⑤ ⑥ ⑦ ⑧ ⑨ ⑩ ⑪ ⑫
				□ □ - □ □ - □ * □ □ - □ □ □ / Y
① Control Method	PID control with AT (Reverse action) PID control with AT (Direct action) Heat/Cool PID control with AT Heat/Cool PID control with AT for extruder (Air cooling type) Heat/Cool PID control with AT for extruder (Water cooling type)	F D G A W		
② Input and range	See Input range Code Table			
③ Output 1 (OUT1) Control output	See Output 1 Code Table			
④ Output 2 (OUT2) *1, *2 (Control output or analog retransmission output (AO))	Not supplied See Output 2 Code Table	N		
⑤ Power Supply	24V AC/DC 100 to 240V AC	3 4		
⑥ Digital output (DO) *3	Not supplied DO 1 points (DO1) DO 2 points (DO1, DO2) DO 4 points (DO1 to DO4) • Available for RB400/500/700/900 only	N 1 2 4		
⑦ CT input	Not supplied For CTL-6-P-N (0 to 30A) 1 point • When digital output code is "N", cannot be specified. For CTL-12-S56-10L-N (0 to 100A) 1 point • When digital output code is "N", cannot be specified. For CTL-6-P-N (0 to 30A) 2 point • When digital output code is "N", cannot be specified. For CTL-12-S56-10L-N (0 to 100A) 2 point • When digital output code is "N", cannot be specified.	N P S T U		
⑧ Communication/Digital input (DI)	Not supplied RS-485 (ANSI/RKC standard protocol) RS-485 (MODBUS protocol) DI 2 points RS-485 (ANSI/RKC standard protocol) + DI 2 points • Available for RB400/500/700/900 only RS-485 (MODBUS protocol) + DI 2 points • Available for RB400/500/700/900 only	N 5 6 A B C		
⑨ Waterproof/Dustproof	Not supplied Waterproof/Dustproof protection	N 1		
⑩ Case color	White case Black case	N A		
⑪ Quick start code	No quick start code (Default setting) Specify quick start code (DO type)	N 1		
⑫ Instrument version	Version symbol			Y

- *1 When control method is selected for PID control (Code : F, D), output 2 is available for analog retransmission output.
- *2 On the RB100, the event 3 output function can be specified for output 2.
- *3 The number of DO points is limited in some combinations of OUT1 and OUT2 (control output) types.

Input Range Code Table

Temperature Input Group (Field-programmable)

Thermocouple

Input	Code	Range
1	K : 01	0 to 200°C
	K : 02	0 to 400°C
	K : 03	0 to 600°C
	K : 04	0 to 800°C
	K : 05	0 to 1000°C
	K : 06	0 to 1200°C
	K : 41	-200 to +1372°C
	K : 09	0 to 400.0°C
	K : 10	0.0 to 800.0°C
	K : 43	-199.9 to +400.0°C
	K : A1	0 to 800°F
	K : A2	0 to 1600°F
1	K : C7	-328 to +2501°F
	K : C8	-100.0 to +752.0°F
	J : 01	0 to 200°C
	J : 02	0 to 400°C
	J : 03	0 to 600°C
	J : 04	0 to 800°C
	J : 05	0 to 1000°C
	J : 06	0 to 1200°C
J : 15	-200 to +1200°C	
J : 07	-199.9 to +300.0°C	
J : A1	0 to 800°F	
J : A2	0 to 1600°F	
J : B9	-328 to +2192°F	
J : C8	-199.9 to +550.0°F	
2	R : 02	0 to 1769°C
	R : A2	0 to 3216°F

Input	Code	Range
2	S : 02	0 to 1769°C
	S : A2	0 to 3216°F
2	B : 01	400 to 1800°C
	B : A1	800 to 3200°F
1	E : 01	0 to 800°C
	E : A1	0 to 1600°F
1	N : 01	0 to 1200°C
	N : A1	0 to 2300°F
1	T : 02	-199.9 to +100.0°C
	T : 03	-100.0 to +200.0°C
2	W5Re/W26Re (ASTM)	0 to 2000°C
	W : 02	0 to 2320°C
2	A : 01	0 to 1300°C
	A : A2	0 to 2534°F

RTD

Input	Code	Range
Pt100 (JIS/IEC)	D : 01	-199.9 to +649.0°C
	D : 02	-199.9 to +200.0°C
	D : 03	-100.0 to +50.0°C
	D : 04	-100.0 to +100.0°C
	D : 05	-100.0 to +200.0°C
	D : 06	0.0 to 50.0°C
	D : 07	0.0 to 100.0°C
	D : 08	0.0 to 200.0°C
	D : 09	0.0 to 300.0°C
	D : 10	0.0 to 500.0°C
JPt100 (JIS)	D : A2	-199.9 to +400.0°F
	D : A3	-199.9 to +200.0°F
	D : A4	-199.9 to +100.0°F
	D : A5	-199.9 to +300.0°F
	D : A6	0.0 to 100.0°F
	D : A7	0.0 to 200.0°F
	D : A8	0.0 to 400.0°F
	D : A9	0.0 to 500.0°F
	D : B2	-199.9 to +900.0°F
	P : 01	-199.9 to +649.0°C
P : 02	-199.9 to +200.0°C	
P : 03	-100.0 to +50.0°C	
P : 04	-100.0 to +100.0°C	
P : 05	-100.0 to +200.0°C	
P : 06	0.0 to 50.0°C	
P : 07	0.0 to 100.0°C	
P : 08	0.0 to 200.0°C	
P : 09	0.0 to 300.0°C	
P : 10	0.0 to 500.0°C	

DC Current • Voltage Group (Field-programmable)

Input	Code	Range
0 to 1V DC	3 : 01	-1999 to +9999 (Programmable) Factory set value : 0.0 to 100.0
0 to 5V DC	4 : 01	
0 to 10V DC	5 : 01	
1 to 5V DC	6 : 01	
0 to 20mA DC	7 : 01	
4 to 20mA DC	8 : 01	

* For current input, connect is a 250Ω shunt resistor to the input terminals. Model code : KD100-55

- *1 : Accuracy is not guaranteed for less than -100°C (-146°F).
- *2 : Accuracy is not guaranteed for less than 400°C (752°F) for Input Type R, S, B, and W5Re/W26Re.

Output 1 Code Table

Output Type	Code
Relay contact output	M
Voltage pulse output	V
0 to 5V DC	4
0 to 10V DC	5
1 to 5V DC	6
0 to 20mA DC	7
4 to 20mA DC	8
Triac output	T
Open collector output	D

Output 2 Code Table

Output Type	Code
Relay contact output (Cool side output)	M
Voltage pulse output (Cool side output)	V
0 to 5V DC (Cool side output)	4
0 to 10V DC (Cool side output)	5
1 to 5V DC (Cool side output)	6
0 to 20mA DC (Cool side output)	7
4 to 20mA DC (Cool side output)	8
Triac output (Cool side output)	T
Open collector output (Cool side output)	D

Output Type	Code	Remarks
Relay contact output *1 (Event 3 [DO3] output)	P	Only RB100
0 to 20mA DC (Analog retransmission output [AO])	R	Only PID control
4 to 20mA DC (Analog retransmission output [AO])	S	Only PID control
0 to 5V DC (Analog retransmission output [AO])	X	Only PID control
0 to 10V DC (Analog retransmission output [AO])	Y	Only PID control
1 to 5V DC (Analog retransmission output [AO])	Z	Only PID control

*1 : Selectable only when DO 2 points(DO1,DO2) is supplied to RB100 with PID action.

Maximum number of digital outputs (DO) by combinations of output (OUT1 and OUT2)

		OUT2 (Including transmission output)				Current output	Voltage output
		No OUT2 output	M, T, D	V (10 mA)	V (20 mA)		
OUT1	*1 M, T, D	4	4	4	4	4	4
	V (Load: 10 mA)	4	4	4	4	2	2
	V (Load: 20 mA)	4	4	4	2	2	2
	Current output	4	4	2	2	2	2
	Voltage output	4	4	2	2	2	2

(): Represents selection of digital outputs -DO3 and DO4 are not available.)

*1 When the instrument has two digital outputs (DO1 and DO2) and no OUT2 output, "V" type output (load: 40mA) can be specified for OUT1.

Quick start code

- Quick start code tells the factory to ship with each parameter preset to the values detailed as specified by the customer. Quick start code is not necessarily specified when ordering, unless the preset is requested. These parameters are software selectable items and can be re-programmed in the field via the manual.

Specifications	Quick start code	<input type="checkbox"/>	<input type="checkbox"/>	<input type="checkbox"/>	<input type="checkbox"/>	<input type="checkbox"/>
Digital output 1 (DO1) (Event 1 type)	None	N				
Digital output 2 (DO2) (Event 2 type)	None	N				
Digital output 3 (DO3) (Event 3 type) *1	None	N				
Digital output 4 (DO4) (Event 4 type) *2	None	N				
Digital input (DI)	None	N				
	SV1 to SV4 select	1				
	SV1/SV2 select + STOP/RUN	2				
	SV1 to SV2 select + MANUAL/AUTO	3				
	SV1 to SV2 select + Alarm interlock reset	4				
	STOP/RUN + MANUAL/AUTO	5				
	STOP/RUN + Alarm interlock reset	6				
	MANUAL/AUTO + Alarm interlock reset	7				

*1: On the RB100, this can be specified when event 3 (Code : "P") is selected in output 2.

*2: On the RB100, this is fixed at "none".

Event Code Table (Programmable)

Code	Event Type
A	Deviation High
B	Deviation Low
C	Deviation High/Low (Common high/low setting)
D	Band (Common high/low setting)
E	Deviation High with Hold
F	Deviation Low with Hold
G	Deviation High/Low with Hold (Common high/low setting)
H	Process High
J	Process Low
K	Process High with Hold
L	Process Low with Hold
Q	Deviation High with Alarm Re-hold
R	Deviation Low with Alarm Re-hold
T	Deviation High/Low with Re-Hold (Common high/low setting)
U	Band (Individual high and low settings)
V	Set value High
W	Set value Low
X	Deviation High/Low (Individual high and low settings)
Y	Deviation High/Low with Alarm Hold (Individual high and low settings)
Z	Deviation High/Low with Alarm Re-Hold (Individual high and low settings)
1	Heater break alarm (HBA)
2	Loop break alarm
3	FAIL
4	RUN status
5	Output of the communication monitoring result

Example of Model Code and Quick start code

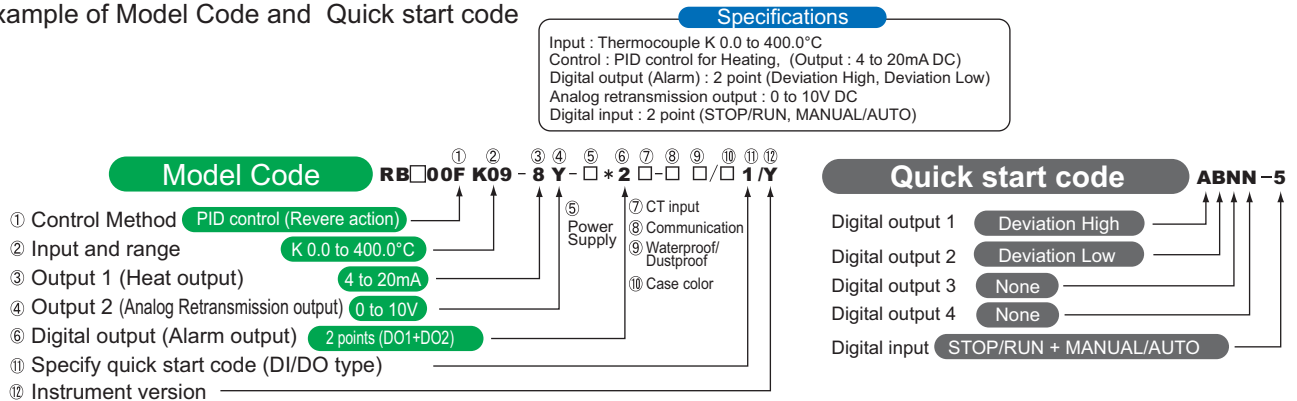

Accessories (Sold separately)

Current transformer for heater break alarm (HBA)

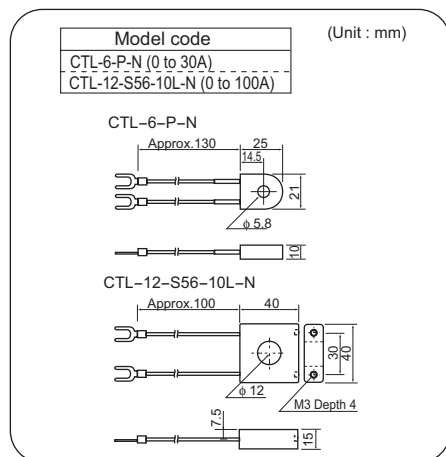

250Ω shunt resistor for current input

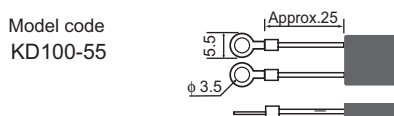

Front Cover

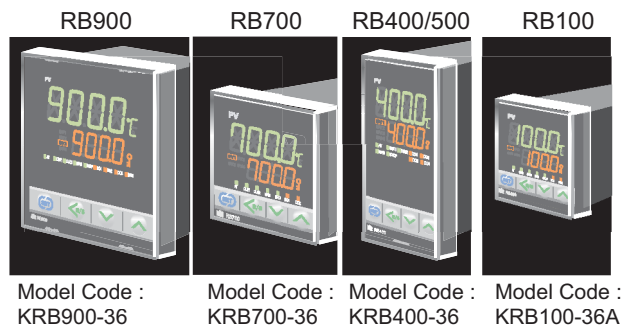

Terminal Cover

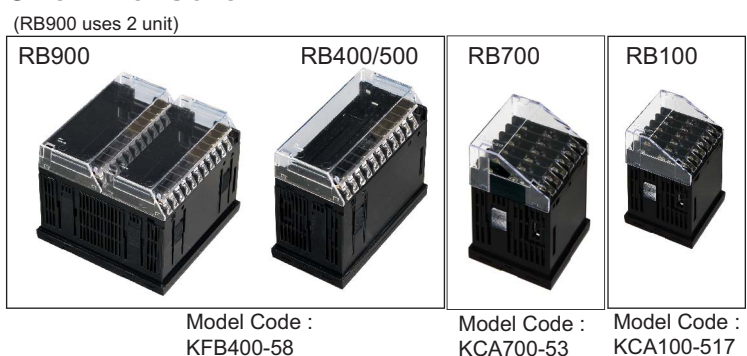

Rear Terminals

• Use a solderless terminal for screw size M3, width 5.8mm or less.

RB900

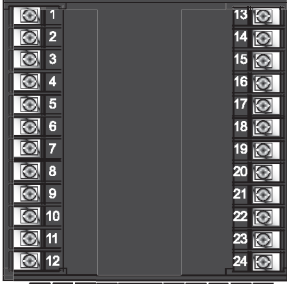

RB400



RB500



RB700



RB100

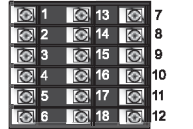

RB400/500/900

No	Contents
1	100 to 240V 24V AC 24V DC
2	Power supply
3	Control output 1, 2 (OUT1,2) or Analog retransmission output (AO)
4	(1) Relay contact output (2) Voltage pulse / Current/Voltage (3) SSR (Triac) (4) Open collector
5	(OUT1)
6	(OUT2) or (AO)
7	(Optional) Digital output 1, 2 (DO1,2)
8	Relay contact output
9	COM
10	Measuring input
11	(1) Thermocouple (2) RTD (3) Voltage/Current
12	

No	Contents
13	SG (Optional)
14	T/R(A) Communication RS-485
15	T/R(B)
16	(Optional) Digital input (DI 1, 2)
17	(DI 2) (DI 1)
18	COM
19	(Optional) Digital output 3, 4 (DO3,4)
20	Relay contact output
21	COM
22	(Optional) CT1,CT2 input
23	CT2 CT1
24	

RB700

No	Contents
1	100 to 240V AC24V DC24V
2	Power supply
3	Control output 1, 2 (OUT1,2) or Analog retransmission output (AO)
4	(1) Relay contact output (2) Voltage pulse / Current/Voltage (3) SSR (Triac) (4) Open collector
5	(OUT1)
6	(OUT2) or (AO)
7	(Optional) Digital output 3, 4 (DO3,4)
8	Relay contact output
9	COM

No	Contents
19	
20	
21	
22	(Optional) Digital input (DI 1, 2)
23	(DI 2) (DI 1)
24	COM
25	(Optional) Communication RS-485
26	T/R(A)
27	T/R(B)

No	Contents
10	(Optional) Digital output 1, 2 (DO1,2)
11	Relay contact output
12	COM
13	(Optional) CT1,CT2 input
14	CT2 CT1
15	COM
16	Measuring input
17	(1) Thermocouple (2) RTD (3) Voltage/Current
18	

RB100

No	Contents
1	100 to 240V 24V AC 24V DC
2	Power supply
3	Control output 1, 2 (OUT1,2) or Analog retransmission output, Digital output (AO)
4	(1) Relay contact output (2) Voltage pulse / Current/Voltage (3) SSR (Triac) (4) Open collector
5	(OUT1)
6	(OUT2) or (AO)

No	Contents
13	(Optional) Communication RS-485
14	T/R(A)
15	T/R(B)
16	(Optional) Digital input (DI 1, 2)
17	(DI 2) (DI 1)
18	COM
19	(Optional) CT1,CT2 input
20	CT2 CT1
21	COM

No	Contents
7	(Optional) Digital output 1, 2 (DO1,2)
8	Relay contact output
9	COM
10	Measuring input
11	(1) Thermocouple (2) RTD (3) Voltage/Current
12	

Panel Cutout Dimensions

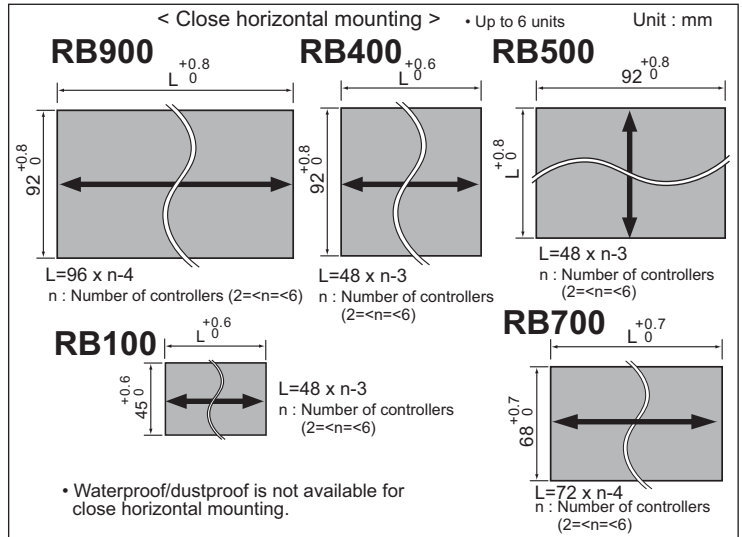
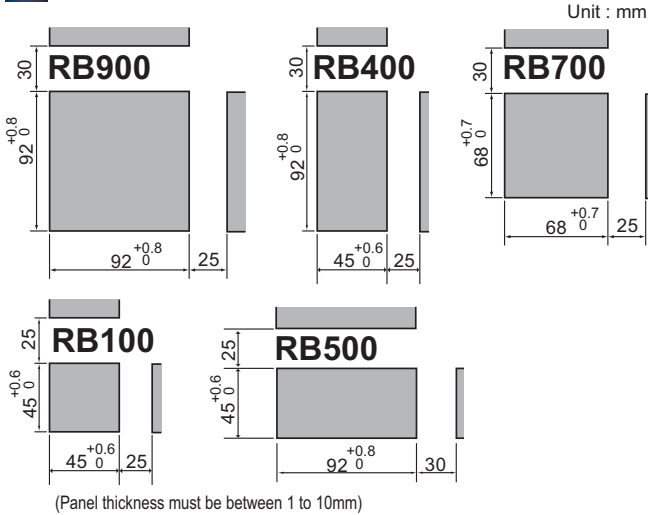

- Before operating this product, read the instruction manual carefully to avoid incorrect operation.
- This product is intended for use with industrial machines, test and measuring equipment. It is not designed for use with medical equipment.
- If it is possible that an accident may occur as a result of the failure of the product or some other abnormality, an appropriate independent protection device must be installed.

Caution for the export trade

All transactions must comply with laws, regulations, and treaties.

Caution for imitated products

As products imitating our product now appear on the market, be careful that you don't purchase these imitated products. We will not warrant such products nor bear the responsibility for any damage and/or accident caused by their use.

RKC® RKC INSTRUMENT INC.
(RIKA KOGYO CO.,LTD)

HEAD OFFICE : 16-6, KUGAHARA 5 CHOME OHTA-KU TOKYO 146-8515 JAPAN
PHONE : 03-3751-9799 (+81 3 3751 9799)
Email : info@rkinst.co.jp
FAX : 03-3751-8585 (+81 3 3751 8585)
http://www.rkinst.com/